

User guide

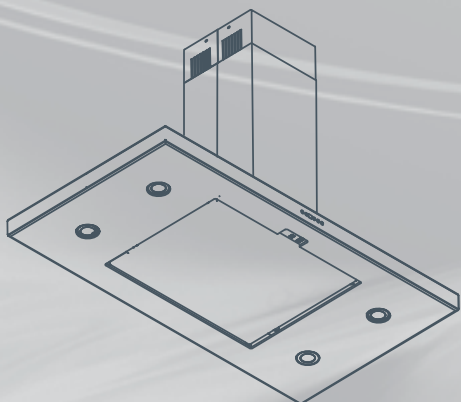

IZONA VentSurface

HC90 and HI120 models

NZ AU

Introduction	3
Safety and warnings	4
Using your VentSurface	5
Care and cleaning	9
Troubleshooting	11
Warranty and service	12

Important!

SAVE THESE INSTRUCTIONS

The models shown in this user guide may not be available in all markets and are subject to change at any time. For current details about model and specification availability in your country, please go to our website www.fisherpaykel.com or contact your local Fisher & Paykel dealer.

Introducing your VentSurface

Congratulations on your new purchase. Your Fisher & Paykel VentSurface is the ultimate in extractor hoods, giving you different modes and extraction speeds to suit your changing needs. Your VentSurface can also operate and turn off automatically and alerts you when it needs cleaning.

Before using your VentSurface

- Make sure the installer has correctly installed your VentSurface.
- Read this guide, taking special note of the 'Safety and warnings' section.
- Make sure the protective blue film covering the stainless steel surfaces has been removed.

4 Safety and warnings

Your safety is important to us. Please read this information before using your VentSurface.

! WARNING!



Electrical Shock Hazard

Always disconnect the appliance from the mains electricity supply before carrying out any servicing or maintenance operations.

Failure to do so may result in electrical shock.

! WARNING!



Hot Surface Hazard

Make sure the elements or gas burners of the cooking surface always have pans/pots on them and never heat the filter(s) of your appliance directly.

When frying, never leave pans unattended as there is a risk of the oil overheating and catching fire.

If reusing frying oil, the risk of fire is greater.

Never prepare flambé (flame-cooked) dishes under the appliance.

To avoid fire hazard, make sure that no grease deposits accumulate on the surface of the appliance or the filter(s).

Read the instructions on care and cleaning carefully. There could be a risk of fire if the instructions are not carefully followed.

Failure to do so could result in burns and scalds.

Important safety precautions

- Make sure that the room in which the appliance is used has adequate ventilation, especially when other appliances burning gas or other fuels are being used at the same time.
- For island models, make sure the ceiling is able to withstand the total weight (56 kg) of the appliance suspended from it. For wall models, make sure the wall is able to withstand the total weight (34 kg) of the appliance mounted on it.
- Take care when removing filters in order to prevent the filter falling and causing damage to the cooking surface.
- Do not leave children alone. Children should not be left alone or unattended in the area where the appliance is in use. They should never be allowed to sit or stand on any part of the appliance. Children or persons with a disability which limits their ability to use the appliance, should have a responsible person to instruct them in its use. The instructor should be satisfied that they can use the appliance without danger to themselves or their surroundings.
- Young children should be supervised to ensure that they do not play with the appliance.
- If the supply cord of this appliance is damaged, it must only be replaced by the manufacturer or its service agent, or a similarly qualified person in order to avoid a hazard.
- Do not use the top surface of the canopy as a storage shelf or place heavy objects on it.
- Do not clean the areas behind the filters.
- Do not use harsh/abrasive cleaners, scouring pads or sharp metal scrapers to clean your appliance.

Control panel features

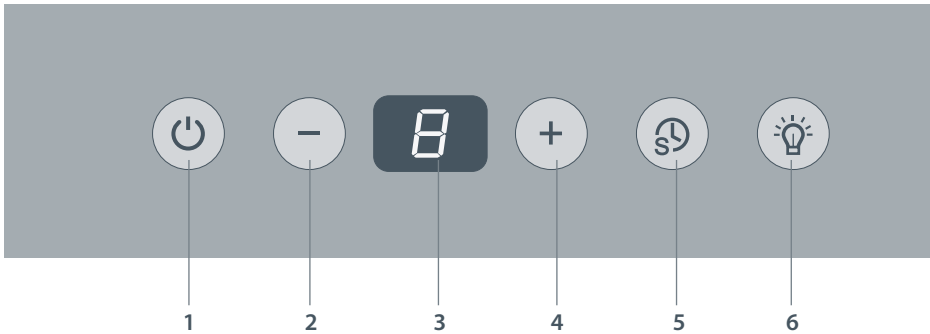

Fig.1 Control panel

- 1 Fan on/off (Stand-by)
- 2 Decreases fan speed
- 3 Mode, speed and cleaning alert display
- 4 Increases fan speed
- 5 Timer
- 6 Lamps on/off

Using your VentSurface for the first time or after a long holiday



- 1 Make sure your cooker or cooktop is turned off and there are no draughts in the room.
- 2 Make sure your VentSurface is on stand-by (ie plugged into a power outlet which is switched on at the wall but the fan is off).
- 3 Press the **-** and **+** buttons simultaneously for three seconds. The VentSurface will beep briefly. You now have manually recalibrated your VentSurface.
- 4 Set the VentSurface to normal or high power mode (see instructions following).
- 5 Set the VentSurface to automatic or manual mode (see instructions following).

6 Using your VentSurface

Choosing between normal and high power modes

These two modes give you flexibility and optimum VentSurface performance to suit your changing cooking activities. Use normal mode for everyday cooking purposes, and high mode during longer periods of intensive cooking (eg holidays or family gatherings) for more powerful venting. Your VentSurface operates in normal mode as a default setting.

To change between normal and high power modes

- 1 Make sure your VentSurface is on stand-by (ie plugged into a power outlet which is switched on at the wall but the fan is off).
- 2 Press the  button and hold down for approximately three seconds.
- 3a The letter "L" will show in the display, indicating that you are in normal power mode.
or
- 3b The letter "H" will show in the display, indicating that you are in high power mode.
- 4 Press the  button and hold down for approximately three seconds to change to the power mode you want. The power mode last selected will be activated.

Choosing between automatic and manual modes

As a default setting, your VentSurface is set to operate in manual mode. It will revert to the default manual mode setting whenever you press the  button to turn the VentSurface off (into stand-by) or unplug it from its power outlet.

To change from manual to automatic mode



- 1 Make sure your VentSurface is on stand-by (ie plugged into a power outlet which is switched on at the wall but the fan is off).
- 2 Press the  button and hold down for three seconds. The VentSurface is now in automatic mode.
- 3a If the sensors in your VentSurface automatically turn the fan on, a green bar will start looping around in the display at a speed proportional to the automatically activated fan speed.
- 3b If the sensors in your VentSurface do not turn the fan on, the letter "S" will appear in the display, reminding you that your VentSurface is now set to automatic mode. The letter "S" will go out after 20 minutes if the sensors do not sense any cooking activity, and your VentSurface will revert to manual mode.

Using your VentSurface in automatic mode

When the VentSurface is in automatic mode, its sensor will automatically turn the fan on, adjust its speed and turn the fan off as needed. To illuminate your cooking area, press the  button to turn the lamps on.

Note: your VentSurface will revert to the default manual mode setting whenever you press the  button to turn the VentSurface off manually (into stand-by) or unplug it from its power outlet.











To change from automatic to manual mode

- To return the VentSurface to manual mode but keep it running, press the  or  buttons. The fan speed setting will be reduced to the lowest, and “1” will show in the display.
- or
- To return the VentSurface to manual mode and turn it off as well, press the  button and hold down for three seconds. The VentSurface will turn off (revert to stand-by).

Using your VentSurface in manual mode

As a default setting, your VentSurface is in manual mode. Depending on your cooking task (intensity of cooking and nature of food), you can choose between six different fan speed settings. For tips on which fan speed to use, see ‘Tips for using the VentSurface’.

To use the VentSurface manually

- 1 Press the  button for two seconds. The fan will turn on and start extracting at speed “3”.
- 1a To turn the lamps on, press the  button.
- 2 Use the  and  buttons to modify the fan speed to suit your needs.
 - If you press the  button briefly, you can reduce the fan speed one step at a time. Pressing the  button and holding it down for at least one second will reduce the speed to the lowest level “1”.
 - If you press the  button briefly, you can increase the fan speed one step at a time. Pressing the  button and holding it down for at least one second will increase the speed to the highest level “6”.
- 3 To turn the VentSurface off (into stand-by), press the  button for two seconds.
- 3a To turn the lamps off, press the  button.

Notes

- If you set the fan to run at the highest speed when in normal power mode (indicated by “6” in the display), your VentSurface and the lamps will automatically turn off after 10 minutes.
- If you set the fan to run at the highest speed when in high power mode (indicated by “6” and “H” flashing alternately in the display), the speed will be automatically reduced to level “5” after 15 minutes.
- You may use the lamps to illuminate the area of your cooker, even if the VentSurface is not in use.
- For your safety, the VentSurface is equipped with a temperature sensor and automatic safety feature. Even if the VentSurface is in manual mode and turned off (on stand-by), it will turn itself on automatically if the system detects a sudden and excessive increase in the surrounding temperature. Depending on the temperature sensed, the VentSurface will automatically turn off after a set time.

8 Using your VentSurface

Using the timer (in manual mode only)

When the timer is activated

- the VentSurface will run for 10 minutes and then turn off automatically.
- the selected fan speed will flash in the display while the timer is counting down.

To activate the timer

- 1 Select a fan speed between “1” and “5”.
- 2 Press the  button briefly, until you hear a short beep.
- 3 The timer function is now activated and your VentSurface and the lamps will automatically turn off after 10 minutes.

Notes on using the timer

- You may deactivate the timer before the 10-minute period is over by pressing the  button briefly until you hear a short beep. The fan speed will stop flashing and the timer is now deactivated.
- You may adjust the fan speed while the timer is counting down.
- If the timer is activated and you increase the fan speed to the highest level “6” when in high power mode, “H” and “6” will flash alternately in the display and the timer will be deactivated. The speed will be automatically reduced to level “5” after 15 minutes, but the VentSurface will keep running.
- If the timer is activated and you increase the fan speed to the highest level “6” when in normal power mode, this does not deactivate the timer and it will continue counting down. If you decrease the fan speed again, this will reset the timer and restart the 10-minute countdown.

Tips for using your VentSurface

Fan speed	Typical cooking task
1	Gentle simmering of a covered pot and reheating.
2	
3	Shallow and deep frying, making jam, simmering multiple covered pots.
4	
5	Rapid boiling of uncovered pots, char-grilling or searing.
6	

- Use your VentSurface on high power mode when cooking intensively for an extended period of time.
- Use your VentSurface on normal power mode for general everyday cooking.
- For best performance when in manual mode, start using the VentSurface about five minutes before starting cooking and allow the VentSurface to operate for 10 minutes after you have finished cooking. The timer function allows you to set the VentSurface to turn off automatically after 10 minutes.

Important!

- Always disconnect the appliance from the mains electricity supply before carrying out any servicing or maintenance. Failure to do so may result in death or electrical shock.
- Do not let grease deposits accumulate on your VentSurface, as these could create a fire hazard.
- Do not use harsh/abrasive cleaners, scourers or sharp metal scrapers to clean your VentSurface.
- Do not clean the areas behind the filters.

How do I know when the filters need cleaning/replacing?

- Your VentSurface is set up to alert you when you need to clean the aluminium mesh filter (after 30 hours of operation) or replace the carbon filter (after 120 hours of operation).
- If the aluminium mesh filter needs cleaning, the letter "A" will start flashing in the display alternately with the fan speed setting. Follow the instructions below.
- If you are using an odour-absorbing carbon filter and it needs replacing, the letter "C" will start flashing in the display alternately with the fan speed setting. Contact Customer Care for instructions on replacing the carbon filter.

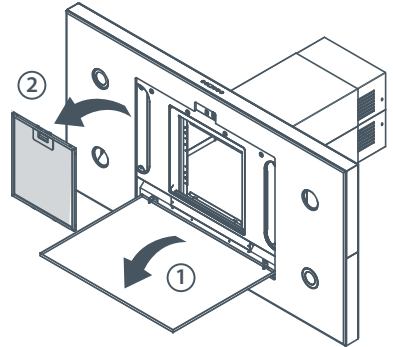





Fig.2 Removing the aluminium mesh filter

To clean the aluminium mesh filter

- 1 Stop/reset the cleaning alert signal.
If "A" is flashing in the display alternately with the fan speed setting, turn the VentSurface off by pressing the  button, then press the  and  buttons simultaneously and hold down for five seconds until you hear a beep. "8" will show in the display until the alert signal has been reset.
- 2 Unplug the VentSurface from the power outlet or switch off at the wall.
- 3 Unclip the magnetic stainless steel cover plate and gently lower it down (Fig.2).
- 4 To remove the aluminium mesh filter, pull gently on the release handle with one hand and support the filter from underneath with the other (to prevent it falling onto the cooking surface).
- 5 Wash the aluminium mesh filter by hand using a mild detergent, or in the dishwasher using a short, 60 °C cycle.
- 6 When dry, replace the aluminium mesh filter.
- 7 Click the protective cover plate back into place.
- 8 Plug the VentSurface back into the power outlet or switch on at the wall.

Cleaning the stainless steel surfaces

Do not use abrasive cleaners, cloths or pads to clean your VentSurface. Wipe the stainless steel surfaces often, using warm water and a mild household detergent. The stainless steel may also be cleaned with a suitable cleaner and polish.

Note: if you choose to use a commercial stainless steel cleaner, please read the label to make sure it does not contain chlorine compounds as these are corrosive and may damage the appearance of your VentSurface.

Replacing the lamps

Wall-mounted (HC90) models have two, and island (HI120) models have four lamps. If you should need to replace the lamps, make sure you are using the correct type of light bulb (G4 halogen bulbs 10W max. each).

- 1 Unplug the VentSurface from the power outlet or switch off at the wall.
- 2 Allow the light bulbs to cool down.
- 3 Locate the outer metal ring of the lamp cover. Pressing it with your fingers, rotate it clockwise firmly, making sure you do not touch the glass cover. The cover will fall out.

Important!

Do not use a screwdriver or any other sharp metal object to force the lamp cover out, as doing so may result in the glass chipping.

- 4 Remove the faulty bulb(s) using a soft cloth. Do not touch the bulb with your fingers.
- 5 Replace with the new bulb(s) using a soft cloth. Make sure the new bulb(s) comply with the specifications above.
- 6 Refit the lamp cover. Place the lamp cover into its hole, making sure it is flush with the glass surface (1). Using your fingers, start rotating the outer metal ring anticlockwise (2). To lock the lamp cover into place, the small gripping hooks on the outer rim of the metal ring need to slide under the black plastic shroud housing the lamp (similarly to a bayonet mount mechanism).
- 7 Plug the VentSurface in or switch the power outlet on at the wall.

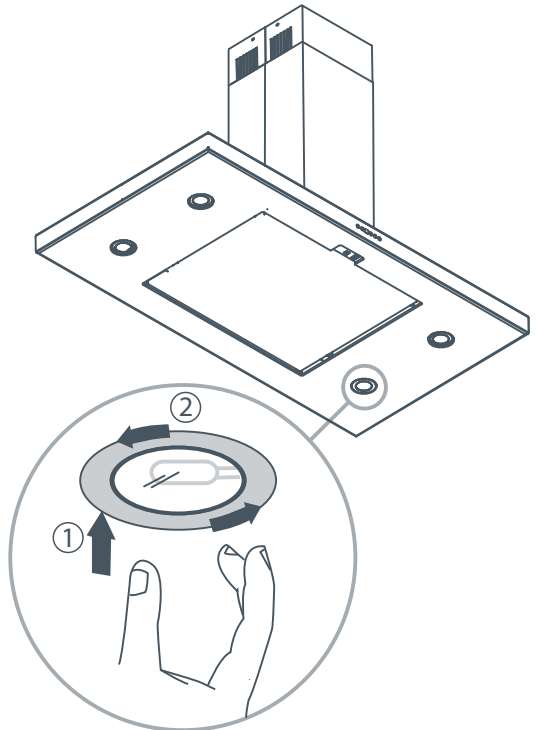

Fig.3 Refitting the lamp cover

Troubleshooting chart

Problem	Cause	What to do
"A" flashing alternately with the fan speed setting.	The aluminium mesh filter needs cleaning (automatic alert).	Clean the aluminium mesh filter following the instructions in section 'Care and cleaning'.
"C" flashing alternately with the fan speed setting.	The carbon filter needs replacing (automatic alert).	Contact Customer Care for instructions on replacing the carbon filter.
"A" or "C" flashing alternately with the fan speed setting, with the fan speed setting flashing twice.	The filter(s) need cleaning/ replacing and the timer is activated.	First deactivate the timer; see the section 'Using the timer'. Then see the problems above.
"8" flashing in display when the VentSurface is in automatic mode.	The VentSurface has detected an error in the automatic sensor.	Return to manual mode. The VentSurface can still be used in manual mode.
The lamp cover will not fall out when rotated clockwise.	The lamp cover is jammed.	Try jiggling the lamp cover sideways. If the problem persists, call your Authorised Service Centre or Customer Care.

12 Warranty and service

Manufacturer's warranty

When you purchase any new Fisher & Paykel rangehood you automatically receive a two year Manufacturer's Warranty covering parts and labour for servicing.

Fisher & Paykel undertakes to

Repair or, at its option, replace without cost to the owner either for material or labour any part of the Product, the serial number of which appears on the Product, which is found to be defective within TWO YEARS of the date of purchase.

This warranty DOES NOT cover

- A Service calls which are not related to any defect in the Product. The cost of a service call will be charged if the problem is not found to be a Product fault. For example:
 1. Correcting installation of the product.
 2. Instructing you how to use the product.
 3. Replacing house fuses or correct house wiring.
 4. Correcting fault(s) caused by the user.
 5. Noise or vibration that is considered normal, eg fan sounds, regeneration noises or user warning beeps.
 6. Correcting damage caused by pests, eg rats, cockroaches etc.
- B Defects caused by factors other than:
 1. Normal domestic use or
 2. Use in accordance with the Product's User Guide.
- C Defects to the Product caused by accident, neglect, misuse or Act of God.
- D The cost of repairs carried out by non-authorized repairers or the cost of correcting such unauthorised repairs.
- E Normal recommended maintenance as set out in the Product's User Guide.
- F Repairs when the appliance has been dismantled, repaired or serviced by other than a Fisher & Paykel AUTHORISED SERVICE CENTRE or the selling dealer.
- G Pick up and delivery.
- H Transportation or travelling costs involved in the repair when the product is installed outside the Fisher & Paykel AUTHORISED SERVICE CENTRE'S normal service area.

Service under this manufacturer's warranty must be provided by an Authorised Service Agent (refer to the Customer care section for contact details). Such service shall be provided during normal business hours. This warranty certificate should be shown when making any claim.

Note:

This Warranty is an extra benefit and does not affect your legal rights and applies only to product purchased in New Zealand and Australia.

Please keep this User Guide in a safe place.

Do not return to Fisher & Paykel.

Customer care



Check the things you can do yourself. Refer to your User Guide and check:

- 1 your appliance is correctly installed
- 2 you are familiar with its normal operation

If after checking these points you still need assistance please refer to the following:

In New Zealand If you need assistance call...*

Call your Fisher & Paykel retailer who is trained to provide information on your appliance, or if we can be of any further help, please contact our Customer Care Centre and talk to one of our Customer Care Consultants.

Toll Free - 0800 FP CARE or 0800 37 2273

Fax: (09) 273 0656

Email: customer.care@fp.co.nz

Postal Address: PO Box 58732, Greenmount
Auckland

In Australia If you need assistance call...*

Call the Fisher & Paykel Customer Care Centre and talk to one of our Customer Care Consultants.

Toll Free - 1300 650 590

Fax: (07) 3826 9298

Email: customer.care@fp.com.au

Postal Address: PO Box 798, Cleveland QLD 4163

If you need service...*

Fisher & Paykel Australia Pty Ltd has a network of independent Fisher & Paykel Authorised Service Centres whose fully trained technicians can carry out any service necessary on your appliance. Our Customer Care Centre can recommend an Authorised Service Centre in your area.

*If you call or write, please provide: name, address, model number, serial number, date of purchase and a description of the problem. This information is needed in order to better respond to your request for assistance.

Product details

Fisher & Paykel Ltd

Model _____ **Serial No.** _____

Date of Purchase _____ **Purchaser** _____

Dealer _____ **Suburb** _____

Town _____ **Country** _____

Copyright © Fisher & Paykel 2008. All rights reserved.

The product specifications in this booklet apply to the specific products and models described at the date of issue. Under our policy of continuous product improvement, these specifications may change at any time. You should therefore check with your Dealer to ensure this booklet correctly describes the product currently available.

www.fisherpaykel.com

NZ AU

VentSurface user guide

Published: 02/2008

Part No. 599479 A